

Spindle Bearing HCB71906-C-T-P4S-UL

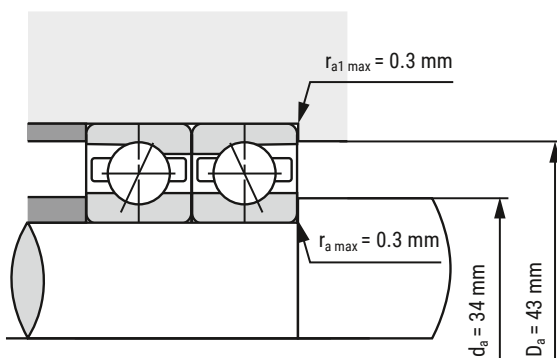
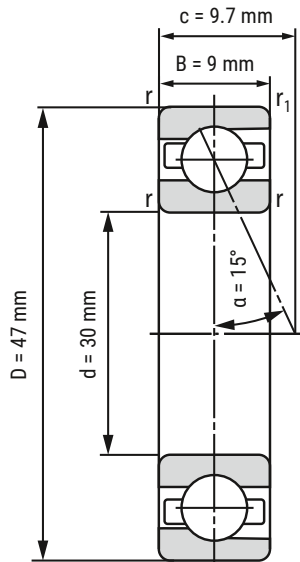

d	30 mm
D	47 mm
B	9 mm

c	9.7 mm	
D_a	43 mm	Tolerance: H12
d_a	34 mm	Tolerance: h12
r_{min}	0.6 mm	
r_{1 min}	0.3 mm	
r_{a max}	0.3 mm	
r_{a1 max}	0.3 mm	
α	15°	Contact angle

m	45 kg	Mass
C_r	8310 N	Basic dynamic load rating, radial
C_{0r}	4390 N	Basic static load rating, radial
F_{VL}	49 N	Preload force
F_{VM}	100 N	Preload force
F_{VH}	200 N	Preload force
C_{aL}	34.2 N/μm	Axial rigidity
C_{aM}	46.6 N/μm	Axial rigidity
C_{aH}	64.1 N/μm	Axial rigidity
n_{G Grease}	43000 r/min	Limiting speed grease lubrication
n_{G Oil}	67000 r/min	Limiting speed oil lubrication

i All indications were made carefully and verified. Kugellager-Express doesn't assume any liability for incomplete or false indications.

HERE YOU'LL FIND THE
ITEM WEBPAGE
(click or scan)

