

Spindle Bearing HCB7012-E-T-P4S-UL

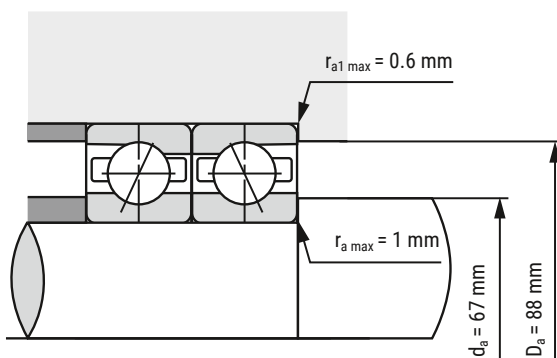
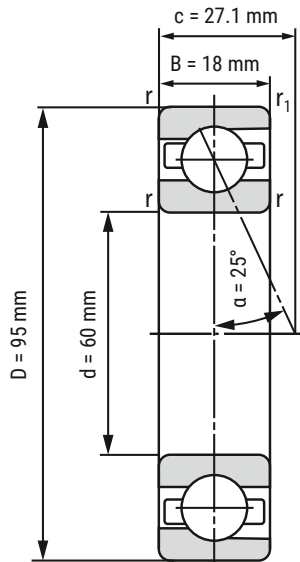

d	60 mm
D	95 mm
B	18 mm

c	27.1 mm	
D_a	88 mm	Tolerance: H12
d_a	67 mm	Tolerance: h12
r_{min}	1.1 mm	
r_{1 min}	0.6 mm	
r_{a max}	1 mm	
r_{a1 max}	0.6 mm	
α	25°	Contact angle

m	333 kg	Mass
C_r	33190 N	Basic dynamic load rating, radial
C_{0r}	20390 N	Basic static load rating, radial
F_{VL}	340 N	Preload force
F_{VM}	780 N	Preload force
F_{VH}	1570 N	Preload force
C_{aL}	203.3 N/μm	Axial rigidity
C_{aM}	278.3 N/μm	Axial rigidity
C_{aH}	368.3 N/μm	Axial rigidity
n_{G Grease}	19000 r/min	Limiting speed grease lubrication
n_{G Oil}	28000 r/min	Limiting speed oil lubrication

i All indications were made carefully and verified. Kugellager-Express doesn't assume any liability for incomplete or false indications.

HERE YOU'LL FIND THE
ITEM WEBPAGE
(click or scan)

