

Spindle Bearing B7210-E-T-P4S-UL

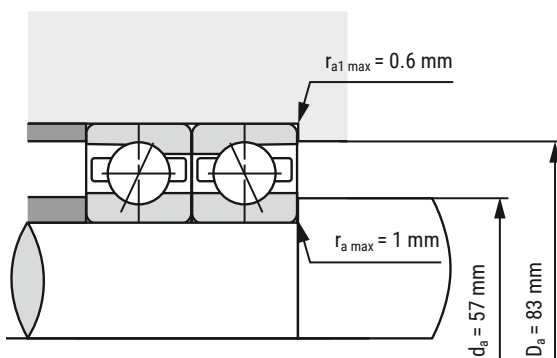
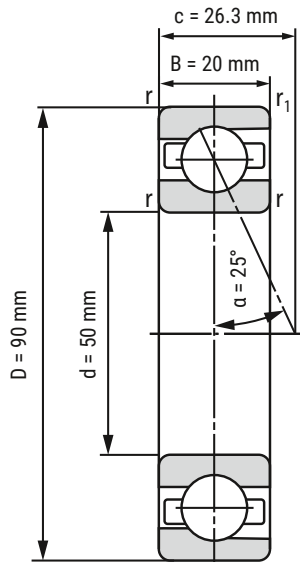

d	50 mm
D	90 mm
B	20 mm

c	26.3 mm	
D_a	83 mm	Tolerance: H12
d_a	57 mm	Tolerance: h12
r_{min}	1.1 mm	
r_{1 min}	0.6 mm	
r_{a max}	1 mm	
r_{a1 max}	0.6 mm	
α	25°	Contact angle

m	446 kg	Mass
C_r	40820 N	Basic dynamic load rating, radial
C_{0r}	30310 N	Basic static load rating, radial
F_{VL}	390 N	Preload force
F_{VM}	980 N	Preload force
F_{VH}	1960 N	Preload force
C_{aL}	149.8 N/μm	Axial rigidity
C_{aM}	211.1 N/μm	Axial rigidity
C_{aH}	277.5 N/μm	Axial rigidity
n_{G Grease}	14000 r/min	Limiting speed grease lubrication
n_{G Oil}	22000 r/min	Limiting speed oil lubrication

i All indications were made carefully and verified. Kugellager-Express doesn't assume any liability for incomplete or false indications.

HERE YOU'LL FIND THE
ITEM WEBPAGE
(click or scan)

