

Spindle Bearing B7209-C-T-P4S-UL

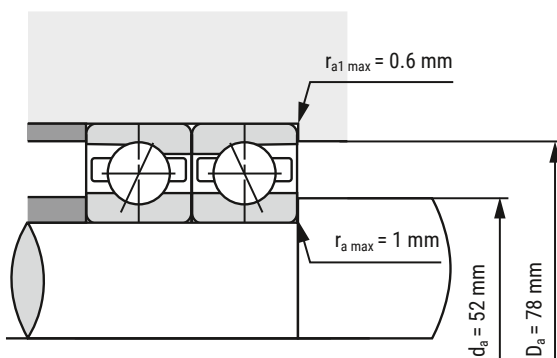
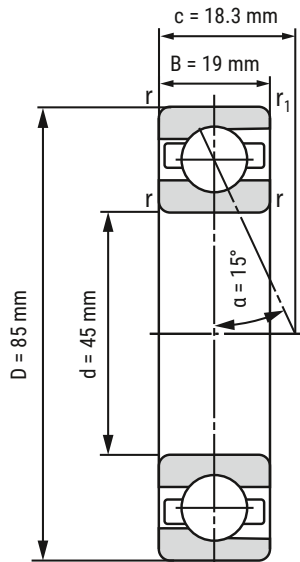

d	45 mm
D	85 mm
B	19 mm

c	18.3 mm	
D_a	78 mm	Tolerance: H12
d_a	52 mm	Tolerance: h12
r_{min}	1.1 mm	
r_{1 min}	0.6 mm	
r_{a max}	1 mm	
r_{a1 max}	0.6 mm	
α	15°	Contact angle

m	423 kg	Mass
C_r	38090 N	Basic dynamic load rating, radial
C_{0r}	27930 N	Basic static load rating, radial
F_{VL}	250 N	Preload force
F_{VM}	540 N	Preload force
F_{VH}	1080 N	Preload force
C_{aL}	61.6 N/μm	Axial rigidity
C_{aM}	86.1 N/μm	Axial rigidity
C_{aH}	119.6 N/μm	Axial rigidity
n_{G Grease}	17000 r/min	Limiting speed grease lubrication
n_{G Oil}	28000 r/min	Limiting speed oil lubrication

i All indications were made carefully and verified. Kugellager-Express doesn't assume any liability for incomplete or false indications.

HERE YOU'LL FIND THE
ITEM WEBPAGE
(click or scan)

