

Spindle Bearing B7208-E-T-P4S-UL

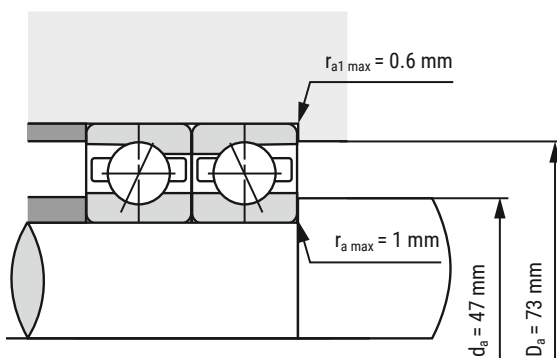
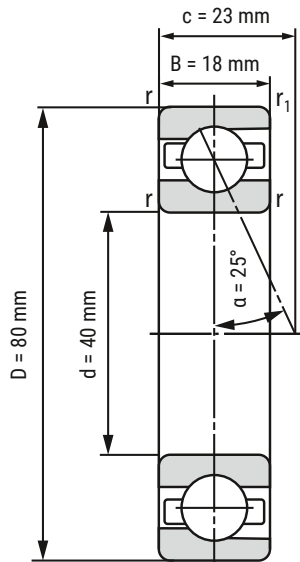

d	40 mm
D	80 mm
B	18 mm

c	23 mm	
D_a	73 mm	Tolerance: H12
d_a	47 mm	Tolerance: h12
r_{min}	1.1 mm	
r_{1 min}	0.6 mm	
r_{a max}	1 mm	
r_{a1 max}	0.6 mm	
α	25°	Contact angle

m	372 kg	Mass
C_r	34710 N	Basic dynamic load rating, radial
C_{0r}	24050 N	Basic static load rating, radial
F_{VL}	290 N	Preload force
F_{VM}	740 N	Preload force
F_{VH}	1470 N	Preload force
C_{aL}	126 N/μm	Axial rigidity
C_{aM}	178.3 N/μm	Axial rigidity
C_{aH}	233.4 N/μm	Axial rigidity
n_{G Grease}	16000 r/min	Limiting speed grease lubrication
n_{G Oil}	26000 r/min	Limiting speed oil lubrication

i All indications were made carefully and verified. Kugellager-Express doesn't assume any liability for incomplete or false indications.

HERE YOU'LL FIND THE
ITEM WEBPAGE
(click or scan)

