

Spindle Bearing B7205-C-T-P4S-UL

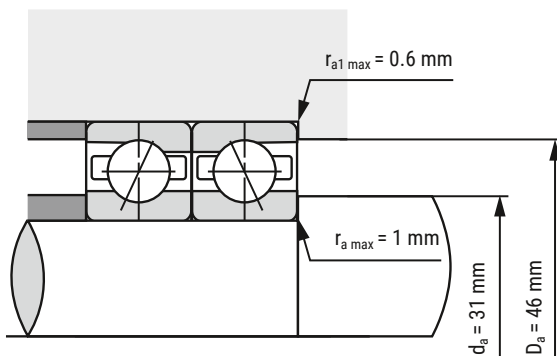
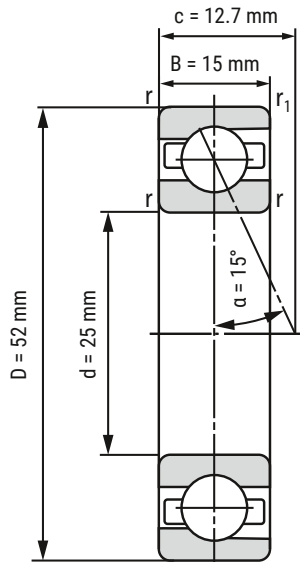

d	25 mm
D	52 mm
B	15 mm

c	12.7 mm	
D_a	46 mm	Tolerance: H12
d_a	31 mm	Tolerance: h12
r_{min}	1 mm	
r_{1 min}	0.6 mm	
r_{a max}	1 mm	
r_{a1 max}	0.6 mm	
α	15°	Contact angle

m	126 kg	Mass
C_r	16590 N	Basic dynamic load rating, radial
C_{0r}	10270 N	Basic static load rating, radial
F_{VL}	78 N	Preload force
F_{VM}	200 N	Preload force
F_{VH}	390 N	Preload force
C_{aL}	32.4 N/μm	Axial rigidity
C_{aM}	48.6 N/μm	Axial rigidity
C_{aH}	66.6 N/μm	Axial rigidity
n_{G Grease}	30000 r/min	Limiting speed grease lubrication
n_{G Oil}	45000 r/min	Limiting speed oil lubrication

i All indications were made carefully and verified. Kugellager-Express doesn't assume any liability for incomplete or false indications.

HERE YOU'LL FIND THE
ITEM WEBPAGE
(click or scan)

