

Spindle Bearing B7201-C-T-P4S-UL

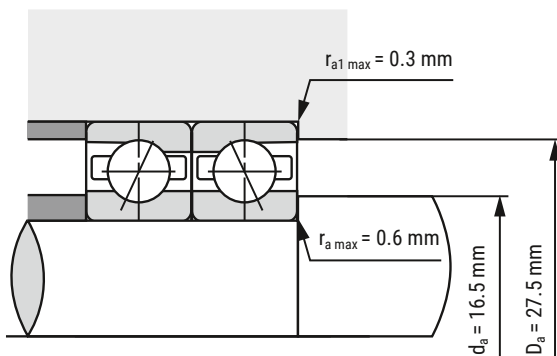
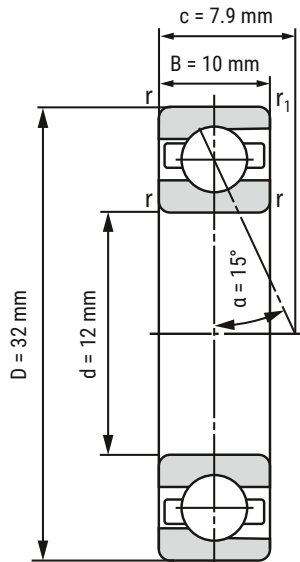

d	12 mm
D	32 mm
B	10 mm

c	7.9 mm	
D_a	27.5 mm	Tolerance: H12
d_a	16.5 mm	Tolerance: h12
r_{min}	0.6 mm	
r_{1 min}	0.3 mm	
r_{a max}	0.6 mm	
r_{a1 max}	0.3 mm	
α	15°	Contact angle

m	37 kg	Mass
C_r	7070 N	Basic dynamic load rating, radial
C_{0r}	3460 N	Basic static load rating, radial
F_{VL}	39 N	Preload force
F_{VM}	100 N	Preload force
F_{VH}	200 N	Preload force
C_{aL}	19.3 N/μm	Axial rigidity
C_{aM}	29.4 N/μm	Axial rigidity
C_{aH}	41.3 N/μm	Axial rigidity
n_{G Grease}	50000 r/min	Limiting speed grease lubrication
n_{G Oil}	75000 r/min	Limiting speed oil lubrication

i All indications were made carefully and verified. Kugellager-Express doesn't assume any liability for incomplete or false indications.

HERE YOU'LL FIND THE
ITEM WEBPAGE
(click or scan)

