

Spindle Bearing B71807-E-T-P4S-UL

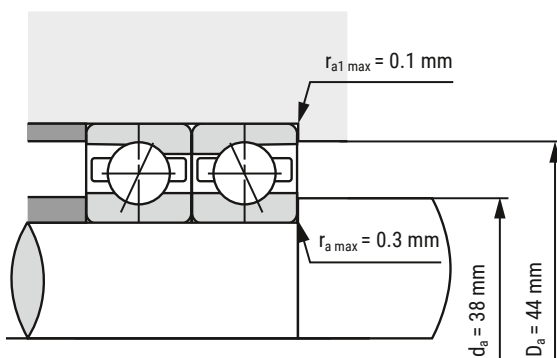
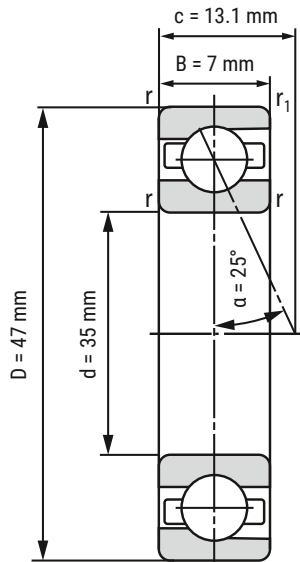

d	35 mm
D	47 mm
B	7 mm

c	13.1 mm	
D_a	44 mm	Tolerance: H12
d_a	38 mm	Tolerance: h12
r_{min}	0.3 mm	
r_{1 min}	0.1 mm	
r_{a max}	0.3 mm	
r_{a1 max}	0.1 mm	
α	25°	Contact angle

m	0.03 kg	Mass
C_r	4360 N	Basic dynamic load rating, radial
C_{0r}	3830 N	Basic static load rating, radial
F_{VL}	19 N	Preload force
F_{VM}	76 N	Preload force
F_{VH}	197 N	Preload force
C_{aL}	45.4 N/μm	Axial rigidity
C_{aM}	83.8 N/μm	Axial rigidity
C_{aH}	121.6 N/μm	Axial rigidity
n_{G Grease}	24000 r/min	Limiting speed grease lubrication
n_{G Oil}	38000 r/min	Limiting speed oil lubrication

i All indications were made carefully and verified. Kugellager-Express doesn't assume any liability for incomplete or false indications.

HERE YOU'LL FIND THE
ITEM WEBPAGE
(click or scan)

