

Spindle Bearing B71801-E-T-P4S-UL

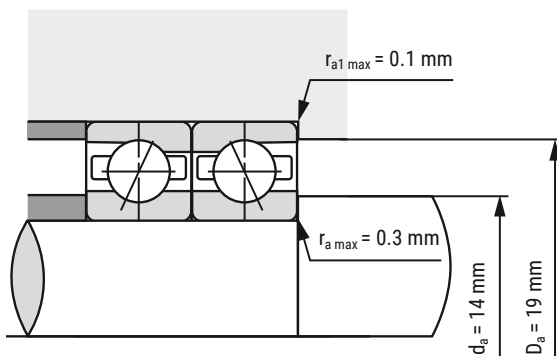
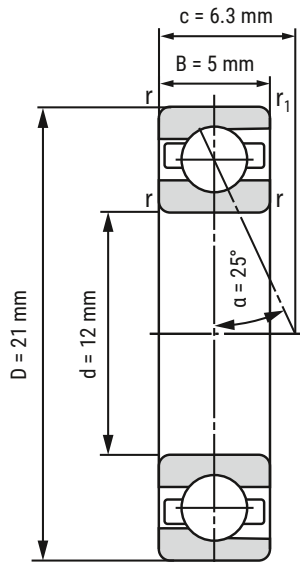

d	12 mm
D	21 mm
B	5 mm

c	6.3 mm	
D_a	19 mm	Tolerance: H12
d_a	14 mm	Tolerance: h12
r_{min}	0.3 mm	
r_{1 min}	0.1 mm	
r_{a max}	0.3 mm	
r_{a1 max}	0.1 mm	
α	25°	Contact angle

m	0.01 kg	Mass
C_r	1960 N	Basic dynamic load rating, radial
C_{0r}	1120 N	Basic static load rating, radial
F_{VL}	8 N	Preload force
F_{VM}	33 N	Preload force
F_{VH}	85 N	Preload force
C_{aL}	23.4 N/μm	Axial rigidity
C_{aM}	37.3 N/μm	Axial rigidity
C_{aH}	56.6 N/μm	Axial rigidity
n_{G Grease}	60000 r/min	Limiting speed grease lubrication
n_{G Oil}	90000 r/min	Limiting speed oil lubrication

i All indications were made carefully and verified. Kugellager-Express doesn't assume any liability for incomplete or false indications.

HERE YOU'LL FIND THE
ITEM WEBPAGE
(click or scan)

