

Spindle Bearing B7013-E-T-P4S-UL

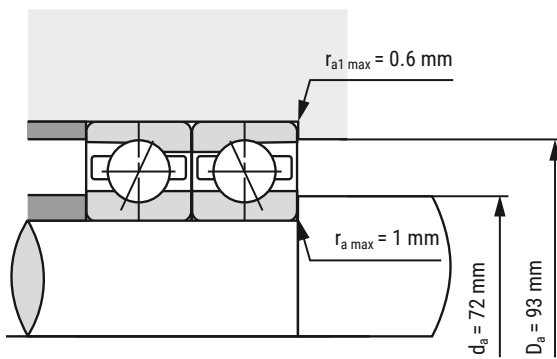
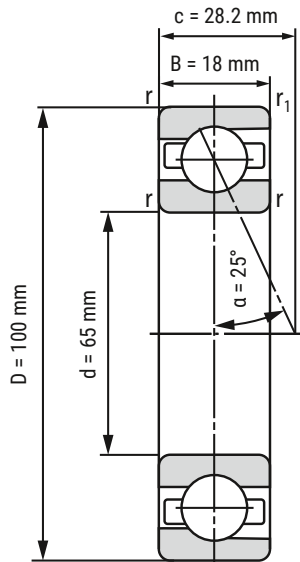

d	65 mm
D	100 mm
B	18 mm

c	28.2 mm	
D_a	93 mm	Tolerance: H12
d_a	72 mm	Tolerance: h12
r_{min}	1.1 mm	
r_{1 min}	0.6 mm	
r_{a max}	1 mm	
r_{a1 max}	0.6 mm	
α	25°	Contact angle

m	426 kg	Mass
C_r	38000 N	Basic dynamic load rating, radial
C_{0r}	33680 N	Basic static load rating, radial
F_{VL}	390 N	Preload force
F_{VM}	880 N	Preload force
F_{VH}	1770 N	Preload force
C_{aL}	175.5 N/μm	Axial rigidity
C_{aM}	237.2 N/μm	Axial rigidity
C_{aH}	311.5 N/μm	Axial rigidity
n_{G Grease}	12000 r/min	Limiting speed grease lubrication
n_{G Oil}	19000 r/min	Limiting speed oil lubrication

i All indications were made carefully and verified. Kugellager-Express doesn't assume any liability for incomplete or false indications.

HERE YOU'LL FIND THE
ITEM WEBPAGE
(click or scan)

