

Spindle Bearing B7007-C-T-P4S-UL

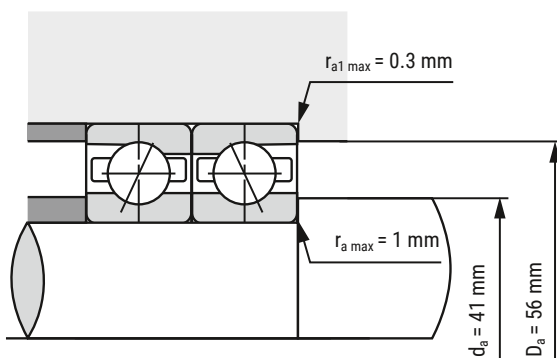
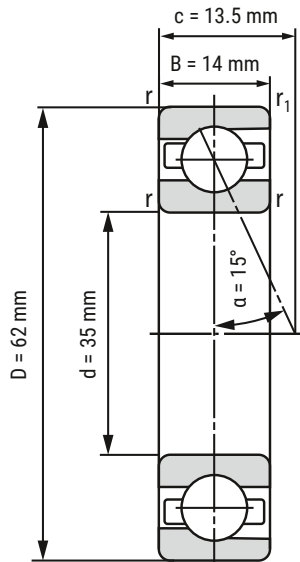

d	35 mm
D	62 mm
B	14 mm

c	13.5 mm	
D_a	56 mm	Tolerance: H12
d_a	41 mm	Tolerance: h12
r_{min}	1 mm	
r_{1 min}	0.6 mm	
r_{a max}	1 mm	
r_{a1 max}	0.3 mm	
α	15°	Contact angle

m	153 kg	Mass
C_r	19130 N	Basic dynamic load rating, radial
C_{0r}	13650 N	Basic static load rating, radial
F_{VL}	120 N	Preload force
F_{VM}	250 N	Preload force
F_{VH}	490 N	Preload force
C_{aL}	44.2 N/μm	Axial rigidity
C_{aM}	60.8 N/μm	Axial rigidity
C_{aH}	83.5 N/μm	Axial rigidity
n_{G Grease}	22000 r/min	Limiting speed grease lubrication
n_{G Oil}	36000 r/min	Limiting speed oil lubrication

i All indications were made carefully and verified. Kugellager-Express doesn't assume any liability for incomplete or false indications.

HERE YOU'LL FIND THE
ITEM WEBPAGE
(click or scan)

