

Spindle Bearing B7004-C-2RSD-T-P4S-UL

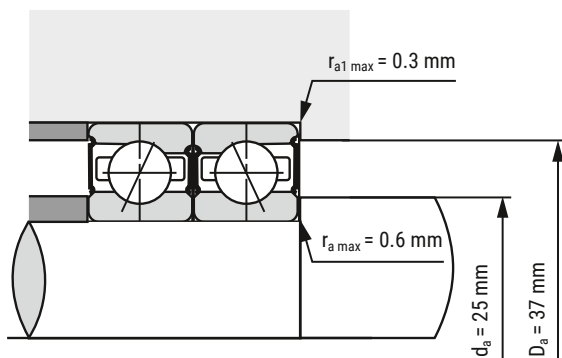
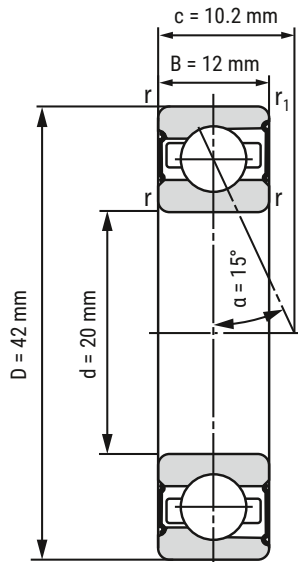

d	20 mm
D	42 mm
B	12 mm

c	10.2 mm	
D_a	37 mm	Tolerance: H12
d_a	25 mm	Tolerance: h12
r_{min}	0.6 mm	
r_{1 min}	0.3 mm	
r_{a max}	0.6 mm	
r_{a1 max}	0.3 mm	
α	15°	Contact angle

m	67 kg	Mass
C_r	11100 N	Basic dynamic load rating, radial
C_{0r}	6560 N	Basic static load rating, radial
F_{VL}	49 N	Preload force
F_{VM}	120 N	Preload force
F_{VH}	250 N	Preload force
C_{aL}	25.7 N/μm	Axial rigidity
C_{aM}	37.8 N/μm	Axial rigidity
C_{aH}	53.3 N/μm	Axial rigidity
n_{G Grease}	38000 r/min	Limiting speed grease lubrication
n_{G Oil}	k.A.	Limiting speed oil lubrication

i All indications were made carefully and verified. Kugellager-Express doesn't assume any liability for incomplete or false indications.

HERE YOU'LL FIND THE
ITEM WEBPAGE
(click or scan)

