

## Spindle Bearing

### B7003-E-2RSD-T-P4S-UL

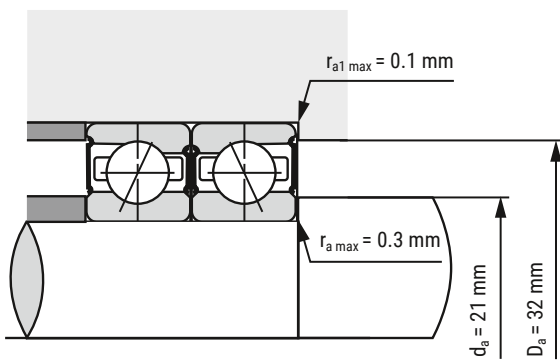
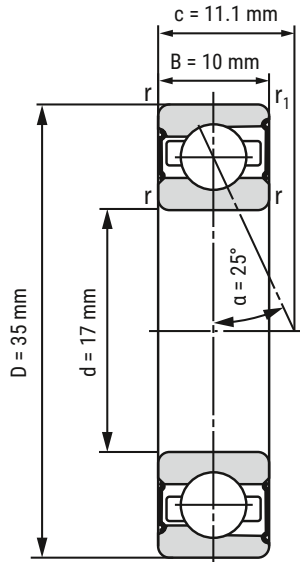

<b>d</b>	17 mm
<b>D</b>	35 mm
<b>B</b>	10 mm

<b>c</b>	11.1 mm	
<b>D<sub>a</sub></b>	32 mm	Tolerance: H12
<b>d<sub>a</sub></b>	21 mm	Tolerance: h12
<b>r<sub>min</sub></b>	0.4 mm	
<b>r<sub>1 min</sub></b>	0.3 mm	
<b>r<sub>a max</sub></b>	0.3 mm	
<b>r<sub>a1 max</sub></b>	0.1 mm	
<b>α</b>	25°	Contact angle

<b>m</b>	43 kg	Mass
<b>C<sub>r</sub></b>	6650 N	Basic dynamic load rating, radial
<b>C<sub>0r</sub></b>	3950 N	Basic static load rating, radial
<b>F<sub>VL</sub></b>	49 N	Preload force
<b>F<sub>VM</sub></b>	120 N	Preload force
<b>F<sub>VH</sub></b>	250 N	Preload force
<b>C<sub>aL</sub></b>	51.5 N/μm	Axial rigidity
<b>C<sub>aM</sub></b>	71.8 N/μm	Axial rigidity
<b>C<sub>aH</sub></b>	95.7 N/μm	Axial rigidity
<b>n<sub>G Grease</sub></b>	40000 r/min	Limiting speed grease lubrication
<b>n<sub>G Oil</sub></b>	k.A.	Limiting speed oil lubrication

**i** All indications were made carefully and verified. Kugellager-Express doesn't assume any liability for incomplete or false indications.

HERE YOU'LL FIND THE  
ITEM WEBPAGE  
(click or scan)

