

Spindle Bearing B7003-C-T-P4S-UL

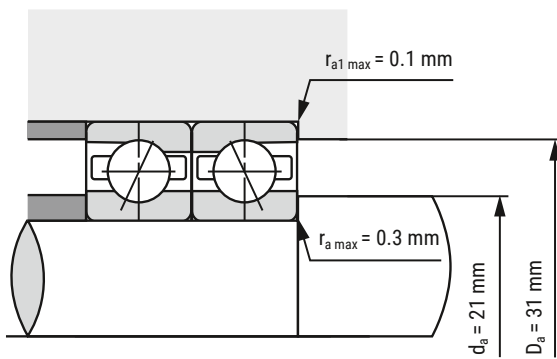
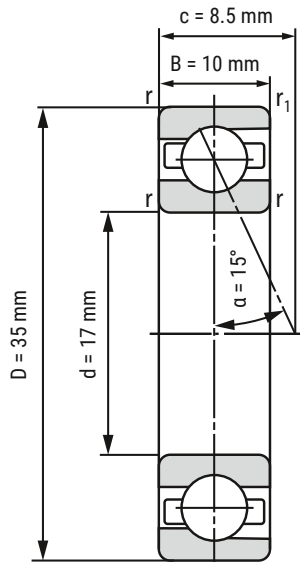

d	17 mm
D	35 mm
B	10 mm

c	8.5 mm	
D_a	31 mm	Tolerance: H12
d_a	21 mm	Tolerance: h12
r_{min}	0.4 mm	
r_{1 min}	0.3 mm	
r_{a max}	0.3 mm	
r_{a1 max}	0.1 mm	
α	15°	Contact angle

m	39 kg	Mass
C_r	6970 N	Basic dynamic load rating, radial
C_{0r}	4120 N	Basic static load rating, radial
F_{VL}	29 N	Preload force
F_{VM}	69 N	Preload force
F_{VH}	150 N	Preload force
C_{aL}	20.7 N/μm	Axial rigidity
C_{aM}	29.9 N/μm	Axial rigidity
C_{aH}	43 N/μm	Axial rigidity
n_{G Grease}	48000 r/min	Limiting speed grease lubrication
n_{G Oil}	70000 r/min	Limiting speed oil lubrication

i All indications were made carefully and verified. Kugellager-Express doesn't assume any liability for incomplete or false indications.

HERE YOU'LL FIND THE
ITEM WEBPAGE
(click or scan)

